

Product MDL-225SR-24

LED indicators MDL - 2000 serie
color red

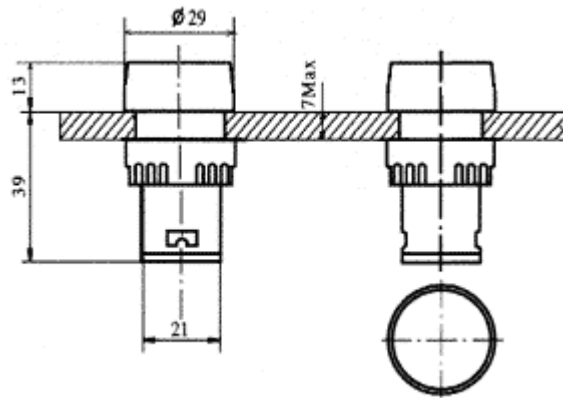

product-catalog	LED indicator
color	red
part no	MDL 2000 R 24
voltage [V]	24-30 (AC/DC)
current [mA]	70
wavelength [nm]	630
intensity [cd/m ²]	>60
rec. mounting hole Ø [mm]	22,5
panel thickness [mm]	max. 7

operating temperature:	-24..+55°C
rel. Humidity:	<98%
Vibration durability:	2..80Hz, acceleration 0.7g
Protection class:	IP 65 - EN60529 / DIN 0470 Part 1
Life expectancy:	>30000 h
Voltage fluctuation:	± 20%
CE approved with:	EN60947-5-1:1997
recommended mounting hole:	22.5 mm

note

- all dimension are in millimeter
- tolerance is ± 0.25 mm unless otherwise noted
- specifications are subject to change without notice
- version 1.0