



IHR PARTNER FÜR LICHTTECHNIK * YOUR SPECIALIST FOR ILLUMINATION



OSHINO LAMPS
Lighted Products since 1931

OSHINO LAMPS GmbH, Tennenloher Straße 19, D 90425 Nürnberg

Vorwort

OSHINO LAMPS
Lighted Products since 1931



Folgende Darstellungen sollen Ihnen lediglich einen kleinen Ausschnitt aus einer Fülle von Möglichkeiten zeigen, Ihre Produkte lichttechnisch zu gestalten.

Neben unterschiedlichen Designs, Größen, Farbtemperaturen und Materialien der folgenden Produkte,

bieten wir Ihnen auch an lichttechnische Komplettlösungen speziell nach Ihren Anforderungen zu entwickeln und herzustellen.

Lassen Sie uns gemeinsam über Ihre individuellen Wünsche und Einsatzgebiete sprechen.

Wir bringen Licht in´s Leben

OSHINO LAMPS
Lighted Products since 1931



Wir bringen Licht in´s Leben

OSHINO LAMPS
Lighted Products since 1931

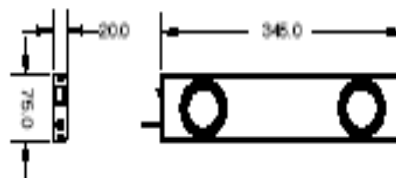
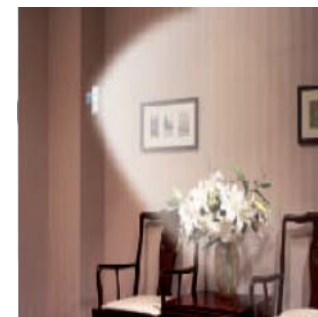
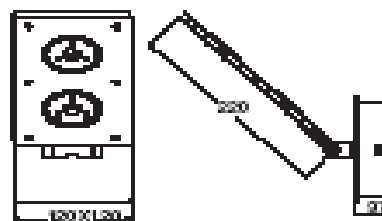
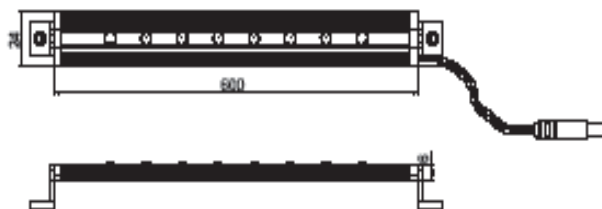

Wir bringen Licht in´s Leben

OSHINO LAMPS
Lighted Products since 1931

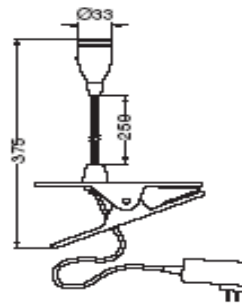
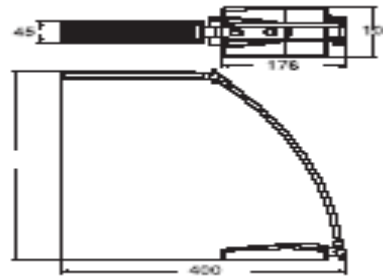

flexible Schwanenhalslampe
mit Clip

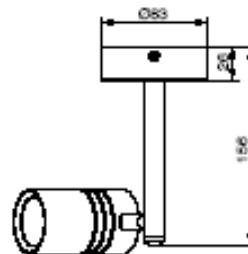

Spotbeleuchtung

Wir bringen
Licht in´s Leben

OSHINO LAMPS
Lighted Products since 1931

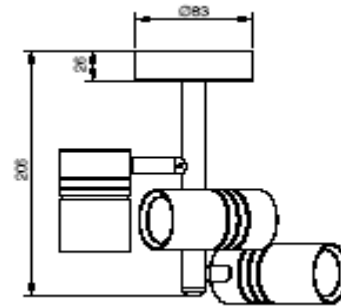

Spotbeleuchtung

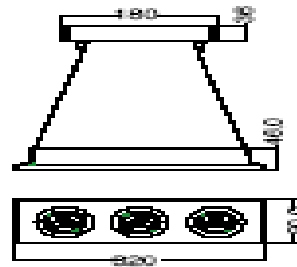

Pendelleuchte

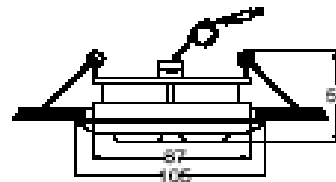

Deckeneinbauleuchte

Wir bringen Licht in´s Leben

OSHINO LAMPS
Lighted Products since 1931

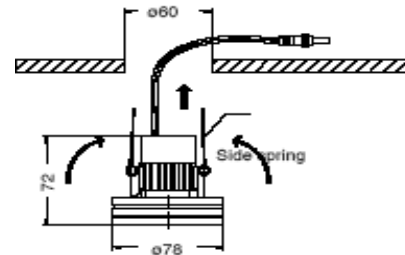

Deckeneinbauleuchte

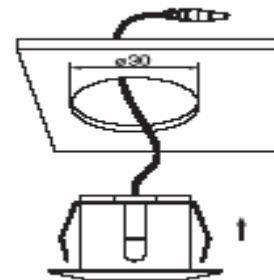

Deckeneinbauleuchte

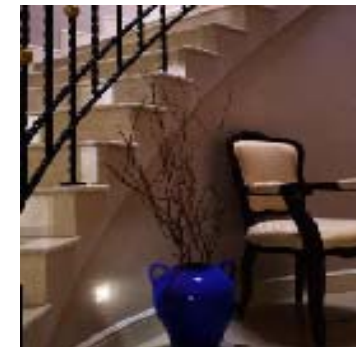
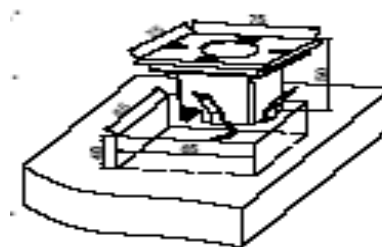

Wir bringen Licht in´s Leben

OSHINO LAMPS
Lighted Products since 1931

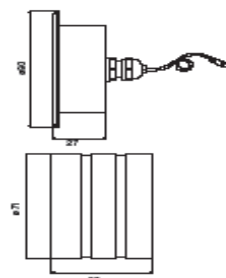
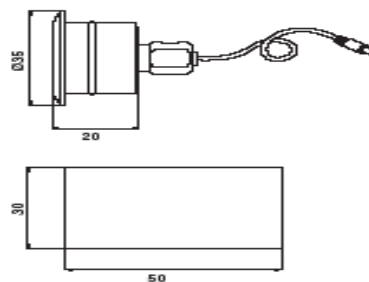
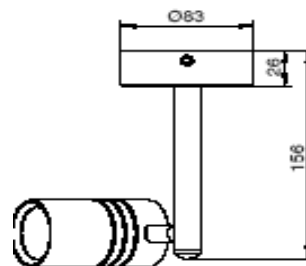

Wir bringen Licht in´s Leben

OSHINO LAMPS
Lighted Products since 1931

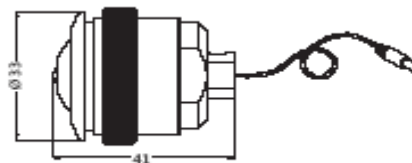
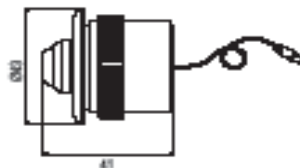

Wir bringen Licht in´s Leben

OSHINO LAMPS
Lighted Products since 1931

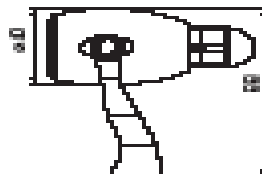

Spot

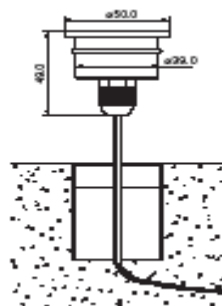

Orientierungslicht

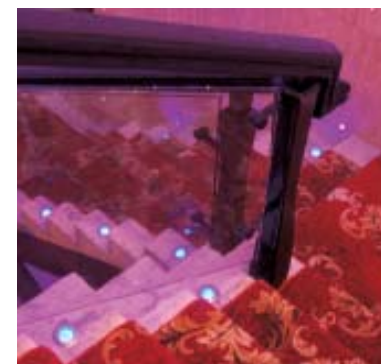
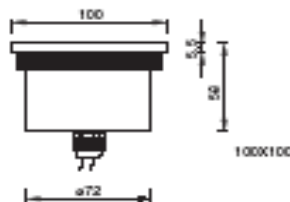

Wir bringen
Licht in´s Leben

OSHINO LAMPS
Lighted Products since 1931

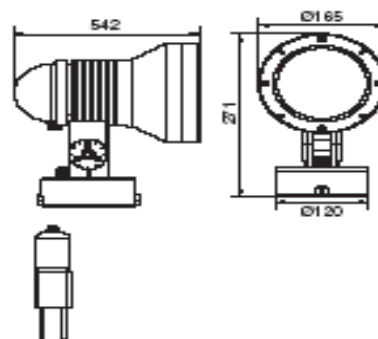

Outdoorspot

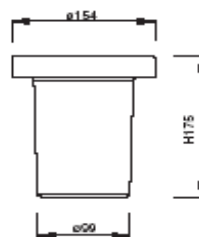

Wir bringen
Licht in´s Leben

OSHINO LAMPS
Lighted Products since 1931

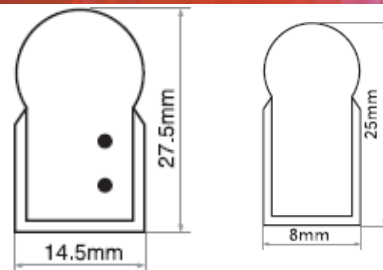

Anwendungsbereich:

z.B. Barbeleuchtung
oder Firmenlogo's und
Schriftzüge



Wir bringen Licht in´s Leben

OSHINO LAMPS
Lighted Products since 1931

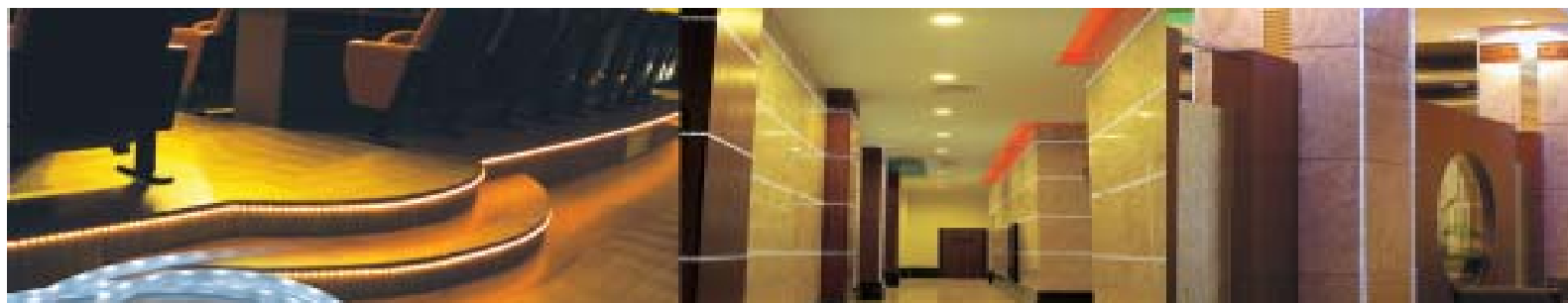
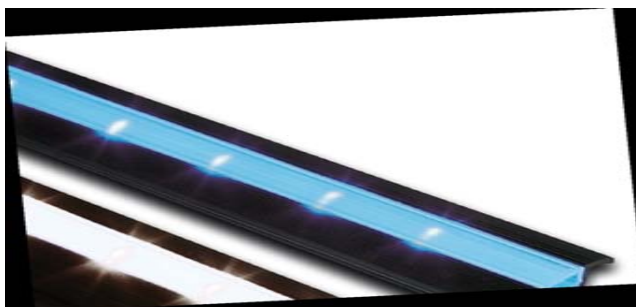
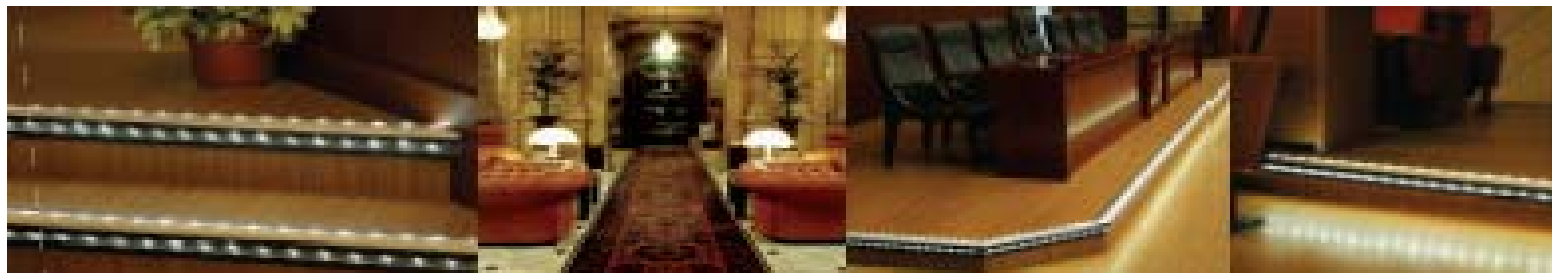

Wir bringen
Licht in´s Leben

OSHINO LAMPS
Lighted Products since 1931

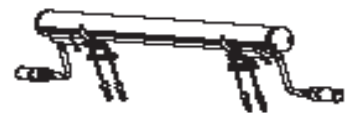

Ø38 LED Mini Tube SC

auch wasserfest erhältlich

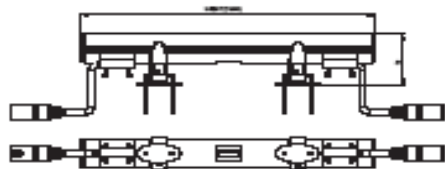

Wir bringen Licht in´s Leben

OSHINO LAMPS
Lighted Products since 1931

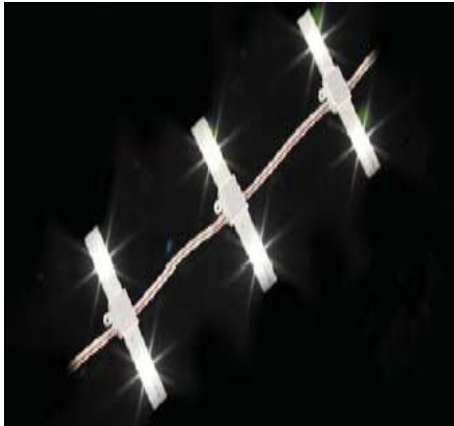

Firmenlogobeleuchtung
Außenbeleuchtung

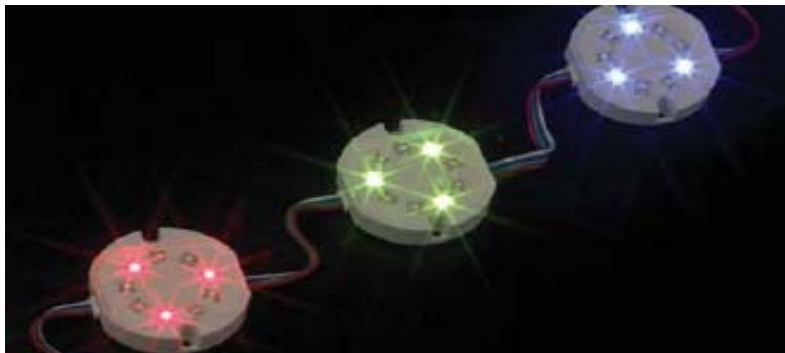
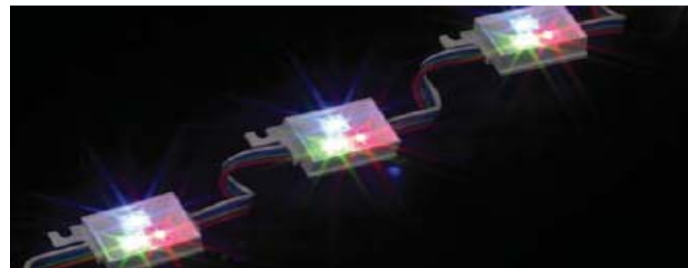

Wir bringen
Licht in´s Leben

OSHINO LAMPS
Lighted Products since 1931



Sternenhimmel

Nachrüstbare
Ambientebeleuchtung





- **OSHINO LAMPS GmbH**
Tennenloher Str. 19
D 90425 Nürnberg
- Tel.: +49-911-934780
Fax: +49-911-9347893
- E-Mail: wolfgang.steuer@oshino-lamps.de
- Internet: www.oshino-lamps.de